

Transistors

# Digital Transistor (Dual Digital Transistors for Inverter Drive)

## EMD9 / UMD9N / IMD9A

●Features

1) DTA114Y and DTC114Y transistors are built-in a EMT or UMT or SMT package.

●Equivalent circuit

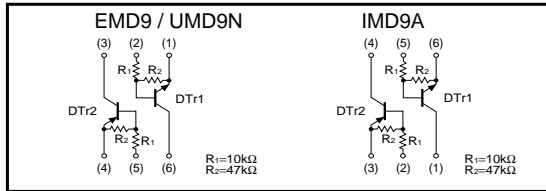

●Package, marking, and packaging specifications

Type	EMD9	UMD9N	IMD9A
Package	EMT6	UMT6	SMT6
Marking	D9	D9	D9
Code	T2R	TR	T108
Basic ordering unit (pieces)	8000	3000	3000

●Absolute maximum ratings (Ta=25°C)

Parameter	Symbol	Limits	Unit
Supply voltage	V <sub>CC</sub>	50	V
Input voltage	V <sub>IN</sub>	-6 to +40	V
Output current	I <sub>O</sub>	70	mA
Collector current	I <sub>C (Max.)</sub>	100	mA
Power dissipation	EMD9, UMD9N	150(TOTAL)	mW *1
	IMD9A	300(TOTAL)	mW *2
Junction temperature	T <sub>J</sub>	150	°C
Storage temperature	T <sub>stg</sub>	-55 to +150	°C

\*1 120mW per element must not be exceeded. PNP type negative symbols have been omitted.  
\*2 200mW per element must not be exceeded. PNP type negative symbols have been omitted.

●Electrical characteristics (Ta=25°C)

Parameter	Symbol	Min.	Typ.	Max.	Unit	Conditions
Input voltage	V <sub>I(off)</sub>	-	-	0.3	V	V <sub>CC</sub> =5V, I <sub>O</sub> =100mA
	V <sub>I(on)</sub>	1.4	-	-		V <sub>O</sub> =0.3V, I <sub>I</sub> =1mA
Output voltage	V <sub>O(on)</sub>	-	0.1	0.3	V	I <sub>O</sub> =5mA, I <sub>I</sub> =0.25mA
Input current	I <sub>I</sub>	-	-	0.88	mA	V <sub>I</sub> =5V
Output current	I <sub>O(off)</sub>	-	-	0.5	mA	V <sub>CC</sub> =50V, V <sub>I</sub> =0V
DC current gain	G <sub>I</sub>	68	-	-	-	I <sub>O</sub> =5mA, V <sub>O</sub> =5V
Transition frequency *	f <sub>r</sub>	-	250	-	MHz	V <sub>CE</sub> =10V, I <sub>E</sub> =-5mA, f=100MHz
Input resistance	R <sub>1</sub>	7	10	13	kΩ	-
Resistance ratio	R <sub>2</sub> /R <sub>1</sub>	3.7	4.7	5.7	-	-

PNP type negative symbols have been omitted.  
\* Characteristics of built-in transistor.

●External dimensions (Unit : mm)

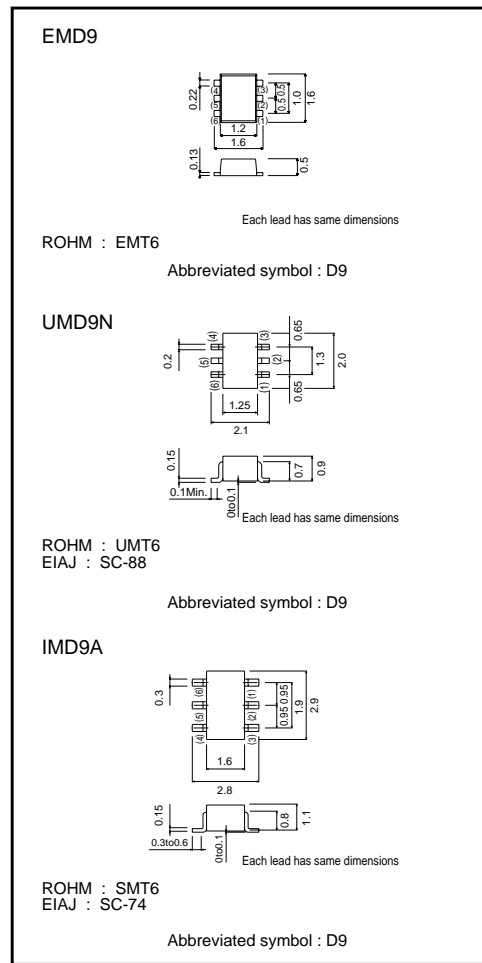

Transistors

●Electrical characteristics curves DTr1 (DTC114Y)

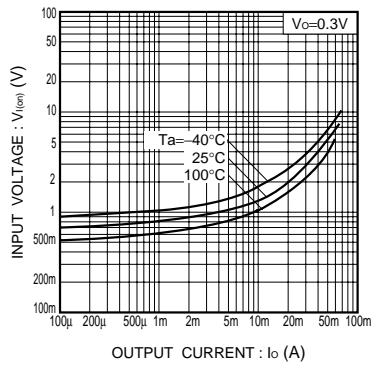

Fig.1 Input voltage vs. output current (ON characteristics)

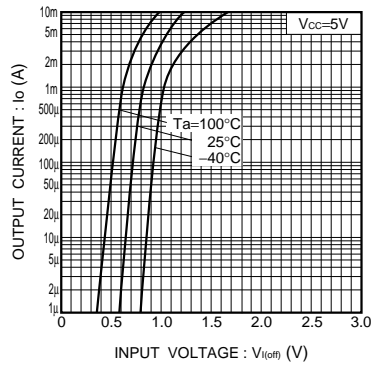

Fig.2 Output current vs. input voltage (OFF characteristics)

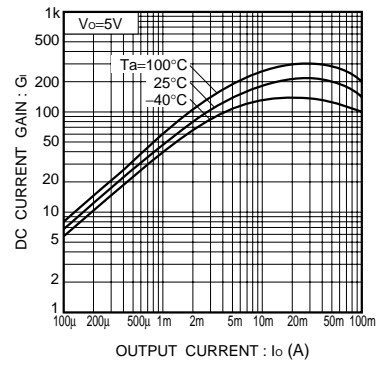

Fig.3 DC current gain vs. output current

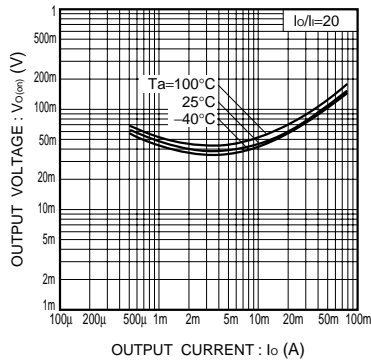

Fig.4 Output voltage vs. output current

Transistors

●Electrical characteristics curves DTr2 (DTA114Y)

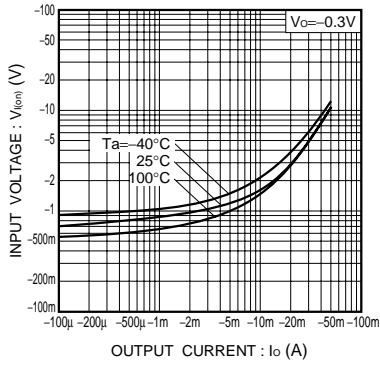

Fig.1 Input voltage vs. output current (ON characteristics)

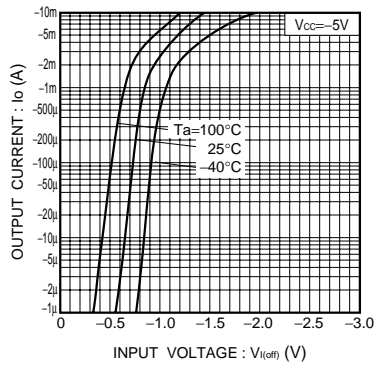

Fig.2 Output current vs. input voltage (OFF characteristics)

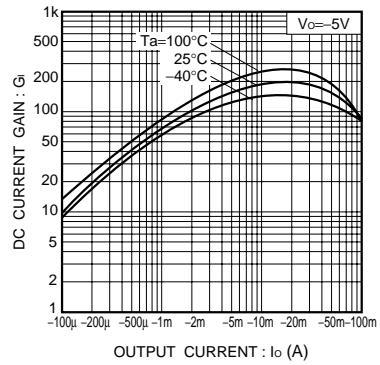

Fig.3 DC current gain vs. output current

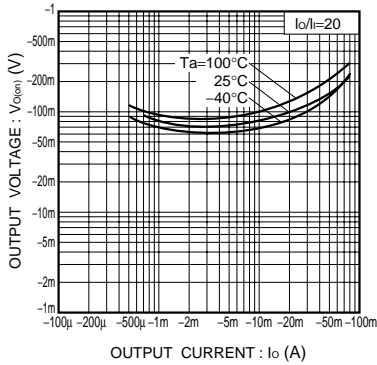

Fig.4 Output voltage vs. output current

### Notes

- No technical content pages of this document may be reproduced in any form or transmitted by any means without prior permission of ROHM CO.,LTD.
- The contents described herein are subject to change without notice. The specifications for the product described in this document are for reference only. Upon actual use, therefore, please request that specifications to be separately delivered.
- Application circuit diagrams and circuit constants contained herein are shown as examples of standard use and operation. Please pay careful attention to the peripheral conditions when designing circuits and deciding upon circuit constants in the set.
- Any data, including, but not limited to application circuit diagrams information, described herein are intended only as illustrations of such devices and not as the specifications for such devices. ROHM CO.,LTD. disclaims any warranty that any use of such devices shall be free from infringement of any third party's intellectual property rights or other proprietary rights, and further, assumes no liability of whatsoever nature in the event of any such infringement, or arising from or connected with or related to the use of such devices.
- Upon the sale of any such devices, other than for buyer's right to use such devices itself, resell or otherwise dispose of the same, no express or implied right or license to practice or commercially exploit any intellectual property rights or other proprietary rights owned or controlled by
- ROHM CO., LTD. is granted to any such buyer.
- Products listed in this document are no antiradiation design.

The products listed in this document are designed to be used with ordinary electronic equipment or devices (such as audio visual equipment, office-automation equipment, communications devices, electrical appliances and electronic toys).

Should you intend to use these products with equipment or devices which require an extremely high level of reliability and the malfunction of which would directly endanger human life (such as medical instruments, transportation equipment, aerospace machinery, nuclear-reactor controllers, fuel controllers and other safety devices), please be sure to consult with our sales representative in advance.

#### About Export Control Order in Japan

Products described herein are the objects of controlled goods in Annex 1 (Item 16) of Export Trade Control Order in Japan.

In case of export from Japan, please confirm if it applies to "objective" criteria or an "informed" (by MITI clause) on the basis of "catch all controls for Non-Proliferation of Weapons of Mass Destruction.